



LDP 12-60 (12.8V 60Ah)

lithium iron phosphate (LiFePO4) battery

**Your best power choice
for energy storage system!**



EverExceed LiFePO4 solutions are more advanced, highly efficient and has many advantages over the traditional Lead Acid technology.

Here introducing popular LDP 12-60 battery of EverExceed which is high demanding among different industry users for its most advanced features.

Application

- Wheel chair, sweeper, electric vehicle, robot
- Solar/wind energy storage system
- UPS Backup power
- Telecommunication
- Medical equipment
- Solar Street light

Advantage summary

- Direct Lead Acid Battery (AGM/GEL) replacement for 60AH;
- Faster charge, 1 hour of charging can provide up to 90% charge (Optional);
- High energy density and conversion efficiency;
- Environmental Friendly, without any heavy metals;
- High cycle times and longer service life of >3000 cycles @100% DOD;
- Great high temperature performance;
- Safety in use: Advanced intelligent BMS inside, No explosion, No fire;
- No maintenance required through out the lifetime;
- Great power saver;
- Superior DOD (100%) over lead acid batteries;
- No acid splash and carbon mono-oxide emission so no need expensive battery maintenance room;
- The integrated BMS can support Bluetooth connectivity with dedicated user friendly app to ease your operation and monitoring (optional);





ELECTRICAL SPECIFICATIONS

Nominal Voltage	12.8 V
Nominal Capacity	60 Ah
Energy	768 Wh
Resistance	≤50 mΩ
Self Discharge	<1.5% per Month
Series connection	4 Units max.
Parallel connection	4 Units max.

CHARGE SPECIFICATIONS

Recommended Charge Current	30 A
Maximum Charge Current	60 A
Recommended Charge Voltage	14.2 V-14.6 V
BMS Charge Voltage Cut-Off	14.6 V (3.65 ±0.5 vpc) (1.1 ±0.4 s)
Reconnect Voltage	14.4 V (3.6 ±0.05 vpc)
Charging method	CC-CV

DISCHARGE SPECIFICATIONS

Maximum Continuous Discharge Current	60 A
Peak Discharge Current	120 A (<2S)
Recommended Low Voltage Disconnect	11 V (2.75 vpc)
BMS Discharge Voltage Cut-Off	8 V (2.0 ±0.08 vpc) (20 ±6 ms)
Reconnect Voltage	10 V (2.5 ±0.05 vpc)
Short Circuit Protection	200-600 μs

TEMPERATURE SPECIFICATIONS

Discharge Temperature	- 4 °F to 140 °F (-20°C to 60 °C)
Charge Temperature	32 °F to 122 °F (0 °C to 50 °C)
Recommend Storage Temperature	23°F to 95 °F (-5°C to 35 °C)

MECHANICAL SPECIFICATIONS

Dimensions (L x W x H)	9.0 x 5.4 x 8.5 " 229 x 138 x 217 mm
Weight	7.5 Kg
Terminal Type	M6
Case Material	ABS
Enclosure Protection	IP55

DIMENSIONAL SPECIFICATIONS

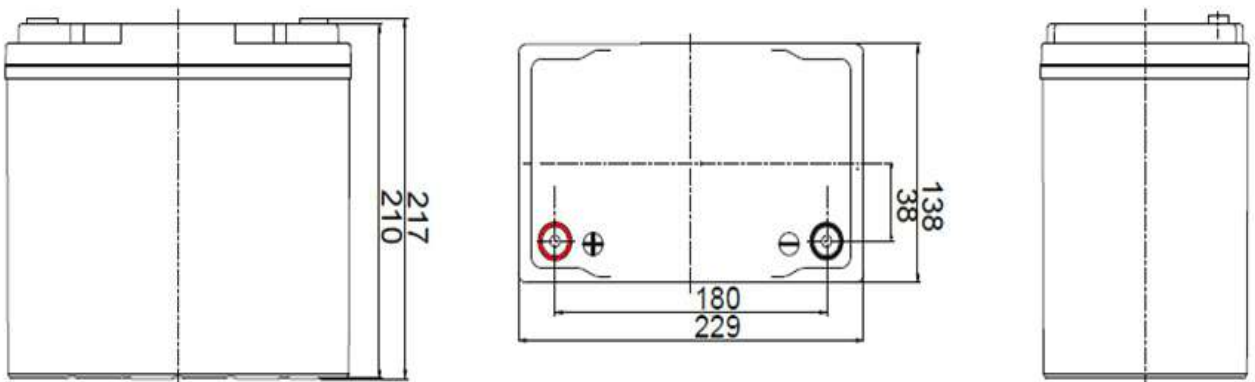



Performance curve

Different Rate Discharge Curve @25°C

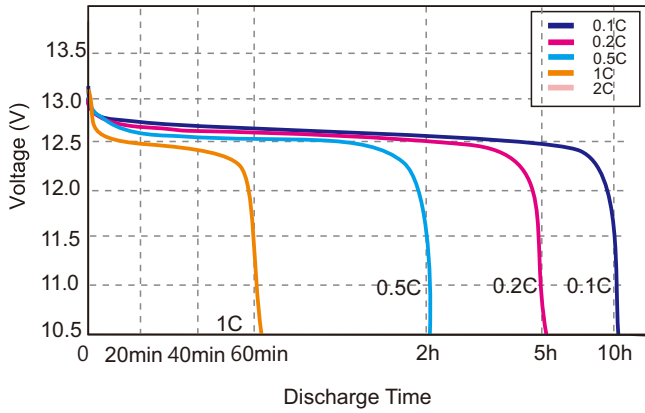

Different Temperature Discharge Curve @0.5C

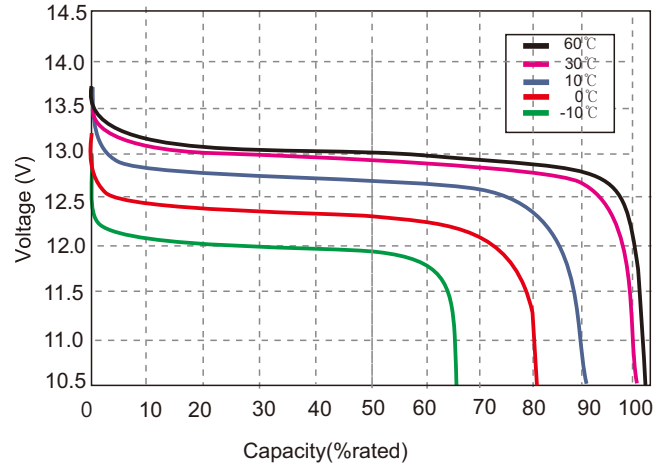

State of Charge Curve @0.5C 25°C

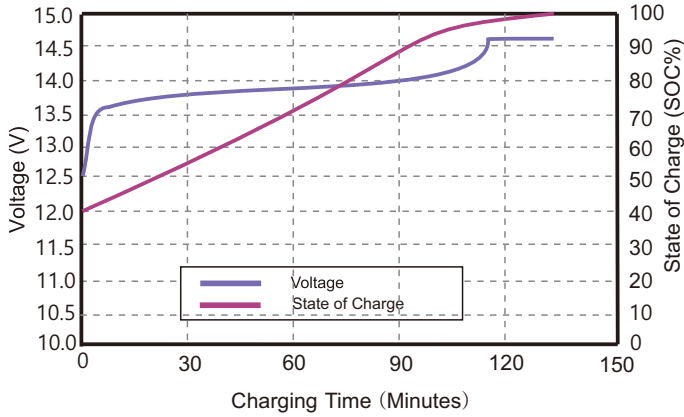

Charging Characteristics @0.5C 25°C

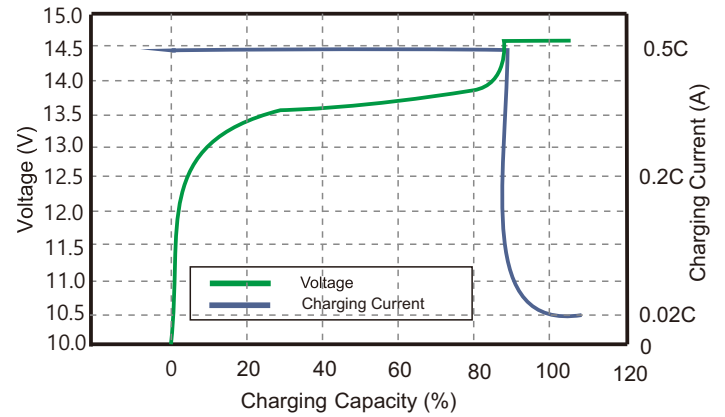

Different DOD Discharge Cycle life Curve @0.2C 25°C

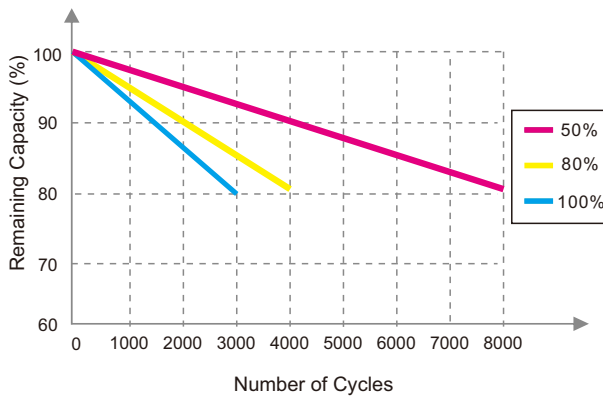

Different Temperature Self Discharge Curve

